

# Hello everyone who drives Ford Ranger.

We know how you have it. That's why we make interiors for you.



Ranger Double Cab



A place for everything.

How much time do you spend on finding the right tool or spare part?

How many minutes a day? How many kilometers a day?

With the right interior and a good order in your van you can spend your time on work.

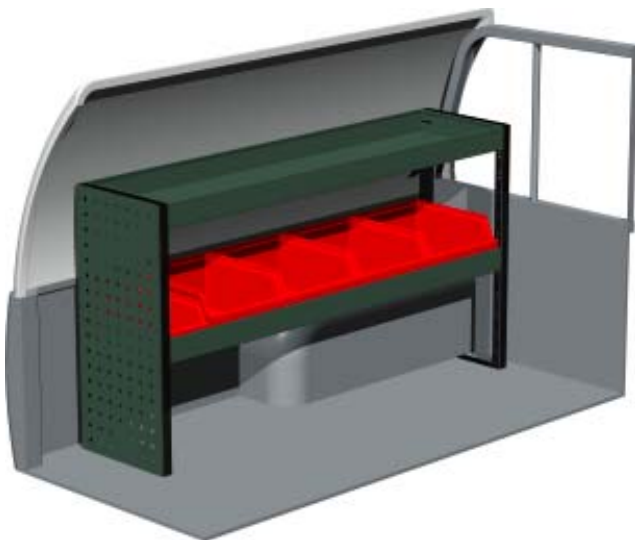

Package No. F60001  
W x D x H 1237 x 300 x 670 mm  
Weight app. 17 kg

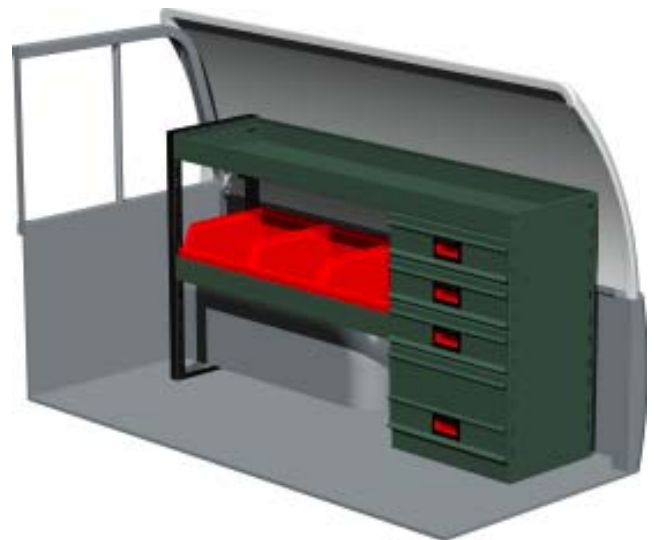

Package No. F60002  
W x D x H 1206 x 300 x 670 mm  
Weight app. 27 kg

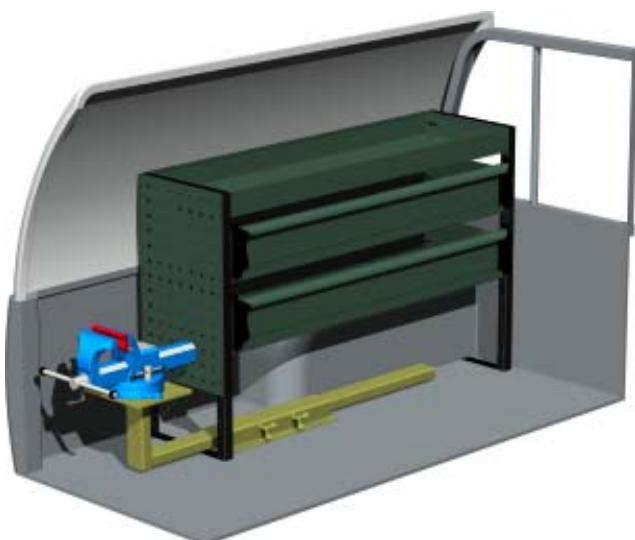

Package No. F60003  
W x D x H 1058 x 300 x 670 mm  
Weight app. 37 kg

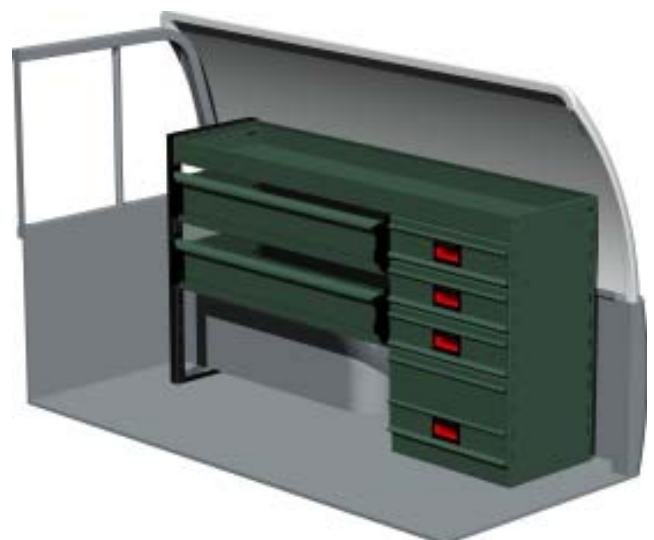

Package No. F60004  
W x D x H 1206 x 300 x 670 mm  
Weight app. 30 kg

# Ford Ranger Double Cab

Document: FRDC-0401

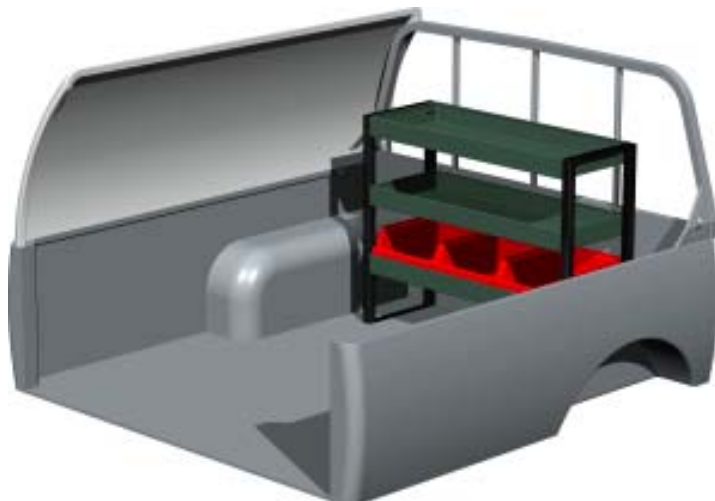

Package No. F60005  
W x D x H 844 x 300 x 670 mm  
Weight app. 15 kg

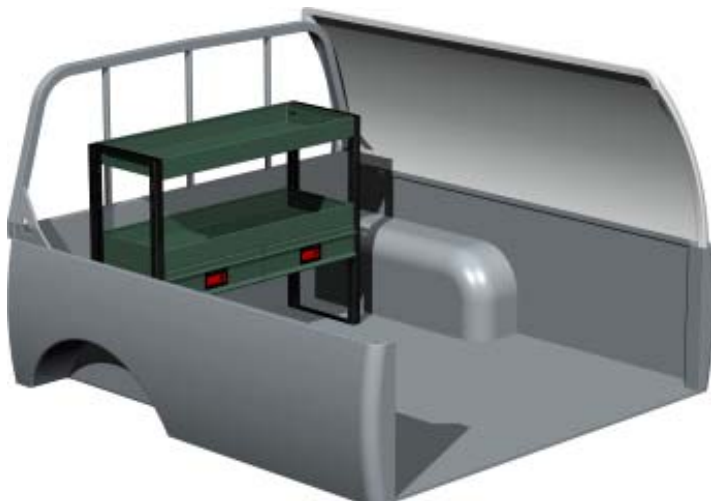

Package No. F60006  
W x D x H 844 x 300 x 670 mm  
Weight app. 17 kg

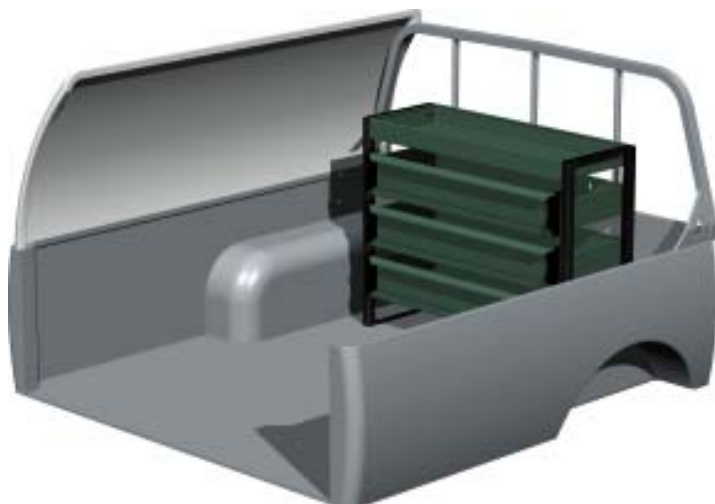

Package No. F60007  
W x D x H 844 x 300 x 670 mm  
Weight app. 19 kg



Package No. F60008  
W x D x H 844 x 300 x 670 mm  
Weight app. 29 kg

**SYSTEM EDSTRÖM**

is qualitytested by:



The packages includes what you see in the drawing and necessary installation parts.

*What you can add:*

Drawer inserts, file holders, tool holders and more.

See us on internet : <http://www.edstrom.se>

Dealer



A place for everything.